

AREM 57U

APS mini reader module in IPDP SLIM panels

User's guide

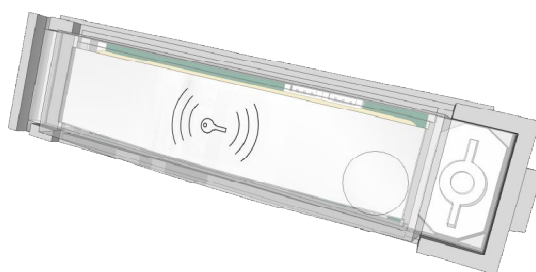

techfass®

1 Content

1	Content.....	2
2	Product Description	3
3	Technical parameters	3
3.1	Product version.....	3
3.2	Technical features.....	4
3.3	Mechanical design	4
4	Installation	5
4.1	Connectors description	5
4.2	Wiring description	5
4.3	Reader module connection	6
4.4	LED Indicators	6
4.5	Installation instructions.....	6
4.6	Mounting and removal of the module	6
5	Setting parameters of the reader module.....	7
5.1	Configurable parameters.....	7
5.2	Reader module parameters setting	7
6	Reader module functioning	7
6.1	“Door Open” function description	8
6.2	Function permanent door lock release according to a time schedule	8
6.3	Standard operating modes.....	8
6.4	Read ID media format.....	8
6.5	Programming mode	9
6.6	Access rights	13
7	Useful links	13

2 Product Description

The **AREM 57U**¹⁾ reader modules (125 kHz readers with an embedded single door controller) are designed for connection to the RS 485 bus of the **APS mini** access control system. It is possible to connect up to 32 reader modules to a single line of the APS mini system. In effect the number of lines is not limited.



Pic. 1: AREM 57U

The modules are supplied as a part of IPDP SLIM panels (design Urmet). The product is distributed by **ALPHATECH TECHNOLOGIES s.r.o.** company.

¹⁾ Commercial designation of available versions is described in *table 1*.

3 Technical parameters

3.1 Product version

Product version	Product designation	Catalogue number	Module features ²⁾		
			TF	EM	HID
	AREM 57U - TF	52457200	✓	✗	✓
	AREM 57U - EM	52457201	✓	✓	✓

Table 1: Product version

²⁾ **TF** – TECHFASS factory ID media reading; **EM** – EM Marin ID media reading; **HID** – HID Proximity ID media reading

3.2 Technical features

Technical features	Supply voltage		8 ÷ 18 VDC
	Current demand	Typical	80 mA
		Maximal	90 mA (8 V)
	Version with keypad		N/A
	ID technology, typical reading range	EM Marin	4 cm (with ISO card)
		HID Proximity	3 cm (with ISO card)
	Real-time clock		Yes
	Memory	Cards	748 ID, 2 programming cards
		Time schedules	64
	Inputs		N / A
	Output	Door lock	1x open collector 0V active – for connection to the REX device of the IPDP SLIM panel
		Alarm	N / A
	Signalization		3x LED 1x PIEZO
	Tamper protection		N / A
Communication interface		RS 485	
Alternative data output		N / A	

Table 2: Technical features

3.3 Mechanical design

Mechanical design	Weight	0,025 kg
	Operating temperature	-25 ÷ 60 °C
	Humidity	Max. 95%, non-condensing
	Housing	IP 44 (built in the entry panel)
	Cable length	2x 0,4 m
	Color	White
	Dimensions	21 x 85 x 21 mm

Table 3: Mechanical design

4 Installation

4.1 Connectors description

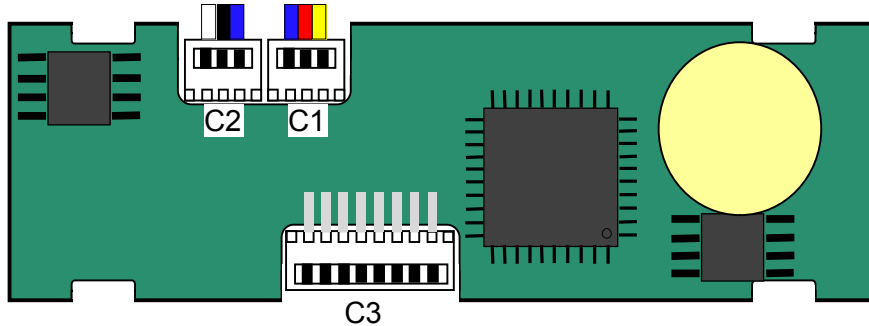

Pic. 2: Connectors for cable connection

Connectors	Connector	Purpose
	C1	Connector for C1 cable connection (blue, red, yellow)
	C2	Connector for C2 cable connection (white, black, blue)
	C3	Service connector

Table 4: Connectors description

4.2 Wiring description

Wiring	Cable C1		Cable C2	
	Color	Purpose	Color	Purpose
	Red	Power +8 ÷ +18 VDC	Blue	GND (0V)
	Blue	GND (0V)	Black	RS485 – A cable
	Yellow	Output 1 – OC	White	RS485 – B cable

Table 5: Wiring description

Attention! Confusion of the cables may cause damage to the module!

4.3 Reader module connection

The C1 cable is standardly soldered to the panel PCB, which provides power supply and door lock control contact for the reader module. For connecting to a PC, the C2 cable must be used.

4.4 LED Indicators

LED indicators	Red	Continuously lit	Online operating mode via RS 485
		Flashing with 4 s period	Offline operating mode
		Fast switching with green	Address setting mode
	Yellow	Continuously lit	Programming mode
		Flashing	Indicating door lock release
	Green		ID media reading

Table 7: LED indicators

4.5 Installation instructions

The reader module uses passive RF/ID technology, which is sensitive to RF noise sources. Noise sources are generally of two types: radiating or conducting.

Conducted noise enters the reader via wires from the power supply or the host. Sometimes, switching power supplies generate enough noise to cause reader malfunction, it is recommended to use linear system power supplies.

Radiated noise is transmitted through the air. It can be caused by computer monitors or other electrical equipment generating electromagnetic fields.

Consequently, a short distance between the reader modules themselves can cause reading malfunctions – for correct operation it is necessary to keep a minimum distance of 50 cm. Various metallic constructions may have a negative influence on this distance; if there are any doubts, it is recommended to perform a practical test before final mounting.

Nearby metal surfaces may cause a decrease in reading distance and speed. This is caused by the combined effects of parasitic capacitance and conductance.

4.6 Mounting and removal of the module

The module is supplied built-in in the IPDP SLIM panel, where it occupies space of a single push button space in a predefined position. For manipulation with the devices please follow the instructions in the user's guide to the IPDP SLIM panel.

5 Setting parameters of the reader module

5.1 Configurable parameters

Configurable parameters	Parameter	Possible range	Default setting
	Door lock release time	0 ÷ 255 s	7 s
	Door lock control setting	Direct / reverse	Direct
	Door lock relay function setting	Standard / toggle	Standard
	Permanent door lock release according to a time schedule	Never / Schedule index	Never
	Door lock status indication	YES / NO	NO
	Acoustic signal of door lock release	YES / NO	YES
	Automatic summer time adjustment	YES / NO	YES

Table 8: Configurable parameters

5.2 Reader module parameters setting

Detailed instructions for setting reader module parameters are described in the *APS Reader* configuration program user's guide available at the address http://www.techfass.cz/files/m_aps_miniplus_reader_en.pdf.

6 Reader module functioning

The reader module supports the following functions:

- Standard "Door Open" function.

The "Door Open" function can be activated in 2 different ways:

- Reading a valid ID (card, key fob...).
- Via communication line (program request).

6.1 “Door Open” function description

In case the *standard function of the door lock relay* is set, the door lock is *released* and the *beeper activated* (when not disabled) when the “Door Open” function is activated. Both outputs stay active until the preset door lock release time has elapsed - see *Tab. 8*.

In case the *toggle function of the door lock relay* is set, the door lock relay status is *switched* and the *beeper is activated* (when not disabled) when the “Door Open” function is activated. The beeper stays active until the preset door lock release time has elapsed - see *Tab. 8*. The door lock relay status remains unchanged until another “Door Open” function is activated.

Reading a programming card during door lock release will not cause the reader to enter the programming mode.

In case the standard function of the door lock relay is set, reading a valid card during door lock release resets the door lock release time.

6.2 Function permanent door lock release according to a time schedule

When the function is set, the door lock is permanently released when relevant time schedule is valid. Reading a valid ID is standardly announced via the communication line (in online operating mode).

The permanent door lock release function and the toggle function of the door lock relay are mutually exclusive.

6.3 Standard operating modes

The reader module can be in either *online* or *offline* operating mode. The module’s functionality is identical in both operating modes; the events archive is read from the reader module’s memory when the module goes online. When a programming card is read (while in either online or offline mode), the module goes into programming mode.

6.4 Read ID media format

6.4.1 EM Marin ID media format

The EM Marin ID media format can be changed into selected 24, 32 or 40 bits length of ID code. The default length is 40 bits. This setting is only used when unifying of the ID media codes length is required – in combined systems with WIEGAND output readers with a fixed WIEGAND data format IDs (more information in *APS Reader* user’s guide available at http://www.techfass.cz/files/m_aps_miniplus_reader_en.pdf).

6.4.2 HID Proximity ID media format

When working with *HID Proximity* technology ID media, the module operates with a code in a recognized 26 or 32 bit format, in other cases it uses all 45 bits of a media (45bit raw format). If a specific format of the *HID Proximity* IDs is required, it can be performed by setting up the user’s configuration of read IDs (more information in *APS Reader* user’s guide available at http://www.techfass.cz/files/m_aps_miniplus_reader_en.pdf).

6.5 Programming mode

The module enters programming mode by reading one of the two *programming cards* (cards “+” and “-“). The programming mode cannot be entered while the module is in hardware address setting mode (for modules with HW address setting via the communication line). The module’s functionality in programming mode can be seen in *pictures 5 a-d*.

It is not possible to use time schedules when inserting cards in programming mode, therefore cards are always valid.

6.5.1 Inserting cards into the reader’s memory

Follow these steps for inserting cards into the reader module’s memory:

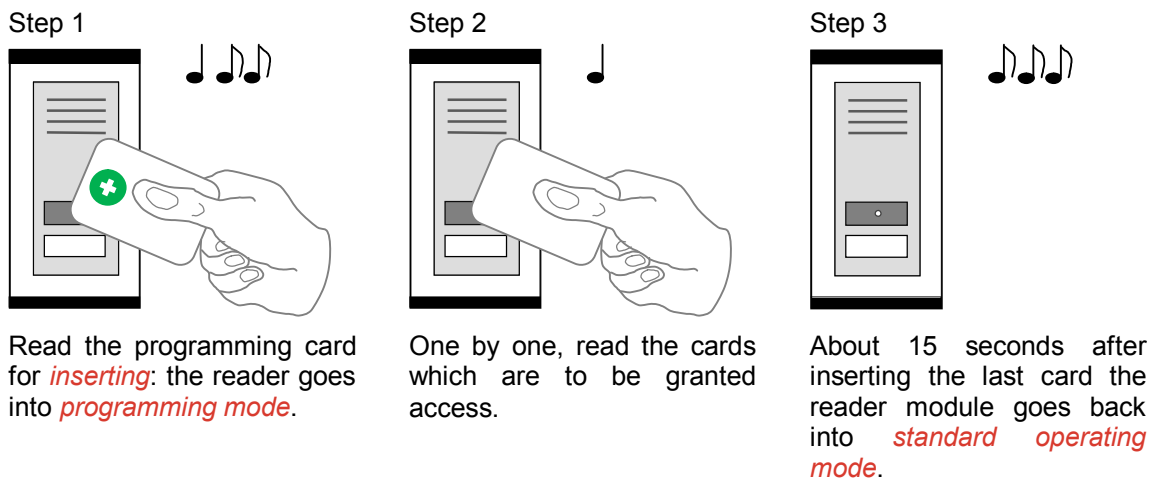

Pic.5 a): Inserting cards

6.5.2 Deleting cards from the reader’s memory

For deleting the cards from the reader module’s memory use following steps:

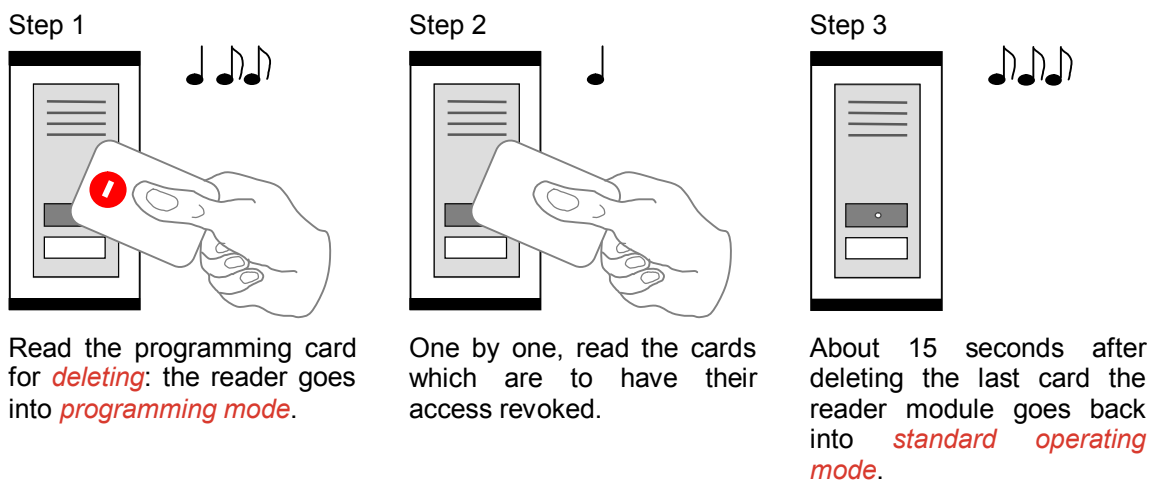

Pic.5 b): Deleting cards

6.5.3 Deleting cards „above or below“

If a user loses his ID medium, it is usually impossible to delete the ID from the memory with the procedure described in the previous chapter, since the medium is no longer available (with an exception of entering the code at the keypad). Following procedure can be used for deleting such ID. The procedure *requires using an ID medium*, which was inserted *right before or right after the ID medium*, which should be deleted.



Read the programming card for *inserting*: the reader goes into *programming mode*, which is indicated by slow flashing of yellow LED.



Read the programming card for inserting 5 times in a row; the reader will go into *Deleting cards "above or below"* mode indicated by fast flashing of yellow LED.

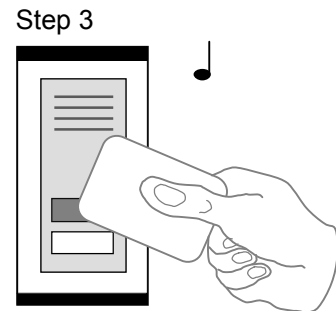

Read a card, which is located in the module's memory *right before or right after* the card you wish to delete. After this step the module quickly flashes with yellow LED.

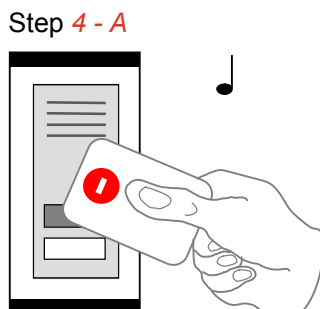

For deleting an ID located *right before* the ID used in previous step, read the programming card for *deleting*.

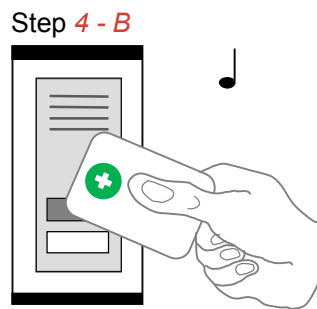

For deleting an ID located *right after* the ID used in previous step, read the programming card for *inserting*.

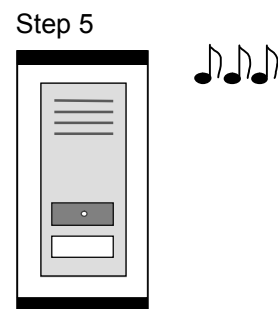

The reader module goes back into *standard operating mode*.

Pic.5 c): Deleting cards "above or below"

6.5.4 Deleting all cards from the reader's memory

Follow these steps for deleting all cards from the reader module's memory:

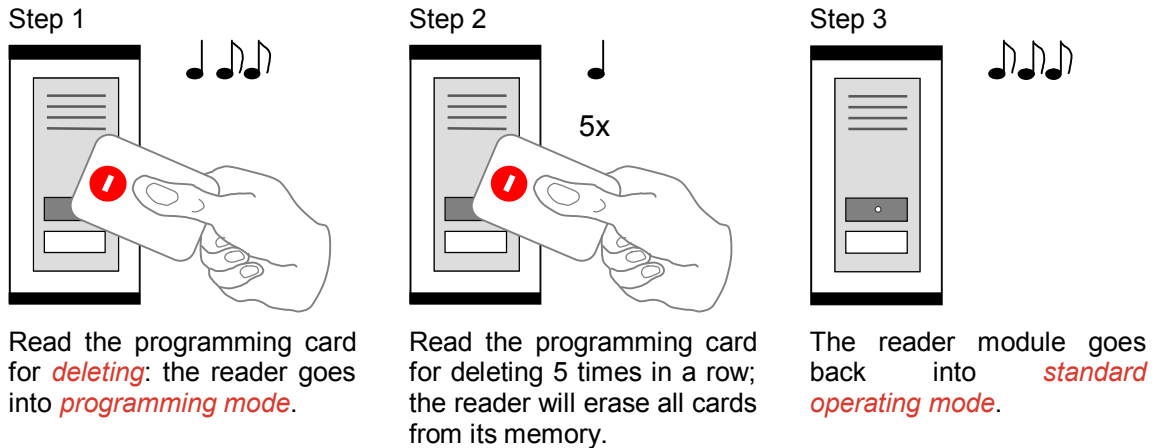

Pic.5 d): Deleting all cards

6.5.5 Recommended method for access rights management (using prog. cards)

In case of managing access rights of plenty of users (using programming cards only), it is appropriate to establish a table, which summarizes operation with the reader module memory. All operations (adding and deleting cards) should be stored in the table. Following example shows correct usage of the programming cards and proper filing of the actions:

- Inserting *5 new cards* using the procedure from chapter 6.5.1 – Read + (*inserting*) *programming card*, read *cards 1-5*, after 15 s the programming mode is exited, *create a table*.

position	card
1	card 1
2	card 2
3	card 3
4	card 4
5	card 5

Pic.5 e): Table after inserting 5 cards

- *Card 3 gets lost* – Delete it *using the card 4*, which is available, and using the procedure from chapter 6.5.3 – Read + (*inserting*) *programming card*, then *5x + (inserting) programming card* again, then *card 4*, and finally – (*deleting*) *programming card*. *Register the change in your table*.

position	card
1	card 1
2	card 2
3	card 3 (lost)
4	card 4 (available)
5	card 5

→

position	card
1	card 1
2	card 2
3	card 3
4	card 4
5	card 5

Pic.5 f): Deleting card 3 using the card 4, table after deleting card 3

- *Card 4 gets lost* – Delete it *using the card 2*, which is available, and using the procedure from *chapter 6.5.3* – Read + *(inserting) programming card*, then *5x + (inserting) programming card* again, then *card 2*, and finally + *(inserting) programming card* again. *Register the change in your table.*

position	card
1	card 1
2	card 2 (available)
3	card 3
4	card 4 (lost)
5	card 5

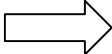

position	card
1	card 1
2	card 2
3	card 3
4	card 4
5	card 5

Pic.5 g): Deleting card 4 using the card 2, table after deleting card 4

- It is necessary to *add another card* (card 6). We proceed with the procedure from *chapter 6.5.1* again. 1 – Read + *(inserting) programming card*, read *cards 1-5*, after 15 s the programming mode is exited. *Register the change in your table.*

position	card
1	card 1
2	card 2
3	card 3
4	card 4
5	card 5
6	card 6

Pic. 5 h): Table after inserting card 6

A new card is always inserted at the position after the last inserted card. In case of deleting all cards using the procedure described in *chapter 6.5.4*, it is necessary to create a new filing table.

6.6 Access rights

The model of access rights contains time schedules and a table of holidays. A block diagram for access right evaluation can be seen in *Pic.6*.

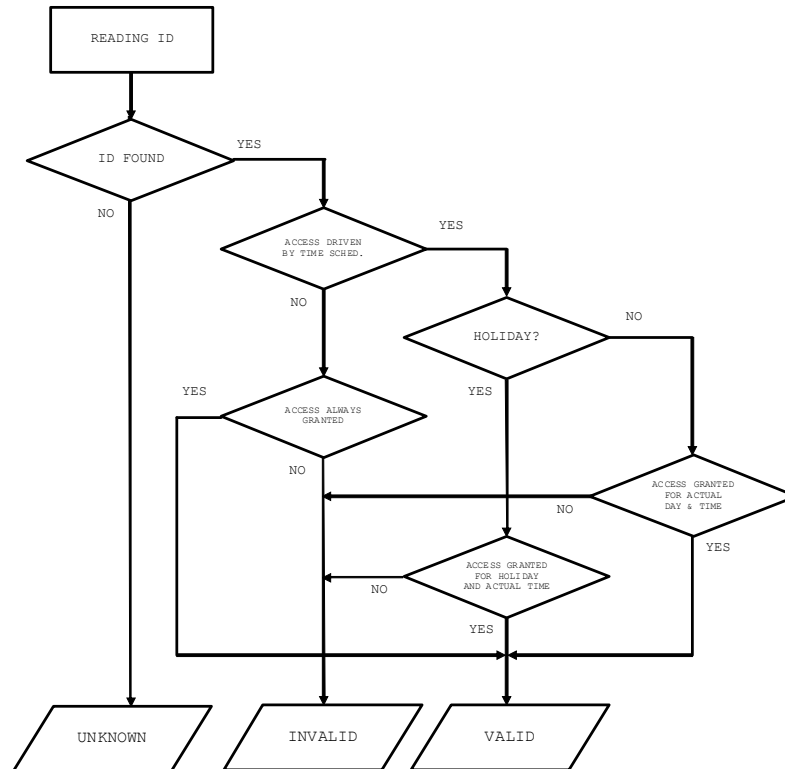

Pic. 6: Access rights evaluation

7 Useful links

- Wiring diagrams: <http://techfass.cz/diagrams-aps-mini-plus-en.html>
- Program equipment: <http://techfass.cz/software-and-documentation-en.html>